

Features

- Includes face plate with handle.
- Single handle controls flow to outlets.
- Supplied with ADA compliant metal lever handle.
- When used with K-728 Series MasterShower diverter valves, handle controls flow to two or three outlets individually or any two outlets at a time.
- When used with K-737 Series MasterShower diverter valves, handle controls flow to two or three outlets individually or only one outlet at a time.
- Valve (not supplied) can be configured on site for two or three outlet operation.
- 360 degree handle rotation with three-outlet operation.
- 120 degree handle rotation with two-outlet operation.
- Complements the Purist® faucet and accessory collections.

Material

- Premium material construction with metal handle ensures reliability and durability.
- KOHLER finishes resist corrosion and tarnishing.

Installation

- Trim only; requires valve to complete installation (sold separately).
- Patented K-joint installation technology ensures consistent trim appearance, regardless of variability in valve rough-in.

Recommended Products/Accessories

K-728-K 3/4" Two- or Three-Way Transfer Valve
K-737-K 3/4" Two- or Three-Way Diverter Valve
K-23723 Faucet cleaner



ADA CSA B651 OBC

Codes/Standards











ASME A112.18.1/CSA B125.1
ADA
ICC/ANSI A117.1
CSA B651
OBC

KOHLER® Faucet Lifetime Limited Warranty

See website for detailed warranty information.

Available Colors/Finishes

Color tiles intended for reference only.

Color	Code	Description
	CP	Polished Chrome
	SN	Vibrant® Polished Nickel
	AF	Vibrant® French Gold
	PGD	Vibrant® Moderne Polished Gold
	BGD	Vibrant® Moderne Brushed Gold
	G	Brushed Chrome
	BN	Vibrant® Brushed Nickel
	BV	Vibrant® Brushed Bronze
	BL	Matte Black
	2MB	Vibrant Brushed Moderne Brass
	RGD	Vibrant Rose Gold

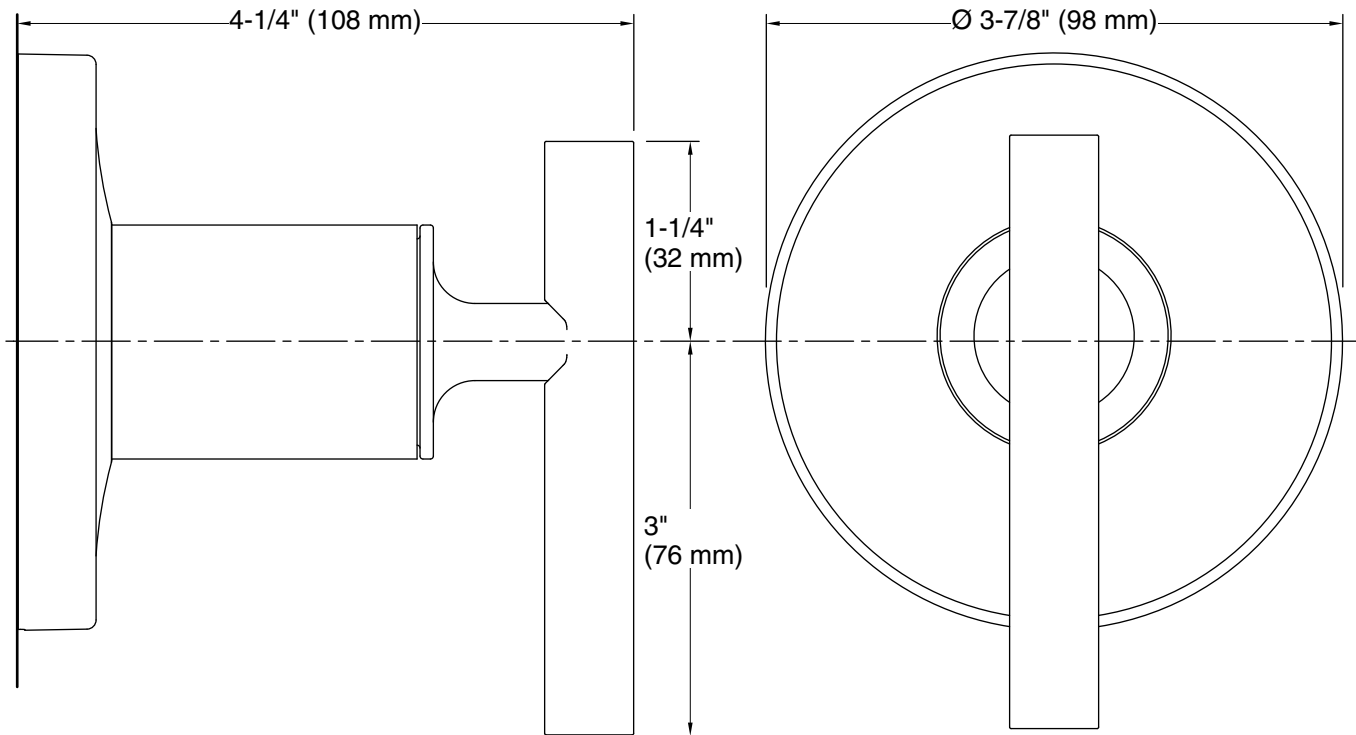

Technical Information

All product dimensions are nominal.

Notes

Install this product according to the installation instructions.

ADA, OBC, CSA B651 compliant when installed to the specific requirements of these regulations.