

Features

- Includes face plate with handle.
- Single handle controls temperature setting.
- Supplied with ADA compliant metal lever handle.
- Complements the Purist® faucet and accessory collections.

Material

- Premium material construction with metal handle ensures reliability and durability.
- KOHLER finishes resist corrosion and tarnishing.

Installation

- Trim only; requires valve to complete installation (sold separately).
- Patented K-joint installation technology ensures consistent trim appearance, regardless of variability in valve rough-in.

Required Products/Accessories

K-2975-KS 3/4" Thermostatic Mixing Valve

or

K-2972-KS 1/2" Thermostatic Mixing Valve

Recommended Products/Accessories

K-23723 Faucet cleaner



ADA CSA B651 OBC

Codes/Standards

ASME A112.18.1/CSA B125.1

ADA

ICC/ANSI A117.1

CSA B651









OBC

KOHLER® Faucet Lifetime Limited Warranty

See website for detailed warranty information.

Available Colors/Finishes

Color tiles intended for reference only.

Color	Code	Description
	CP	Polished Chrome
	SN	Vibrant® Polished Nickel
	AF	Vibrant® French Gold
	BGD	Vibrant® Moderne Brushed Gold
	BN	Vibrant® Brushed Nickel
	BV	Vibrant® Brushed Bronze
	BL	Matte Black
	2MB	Vibrant® Brushed Moderne Brass

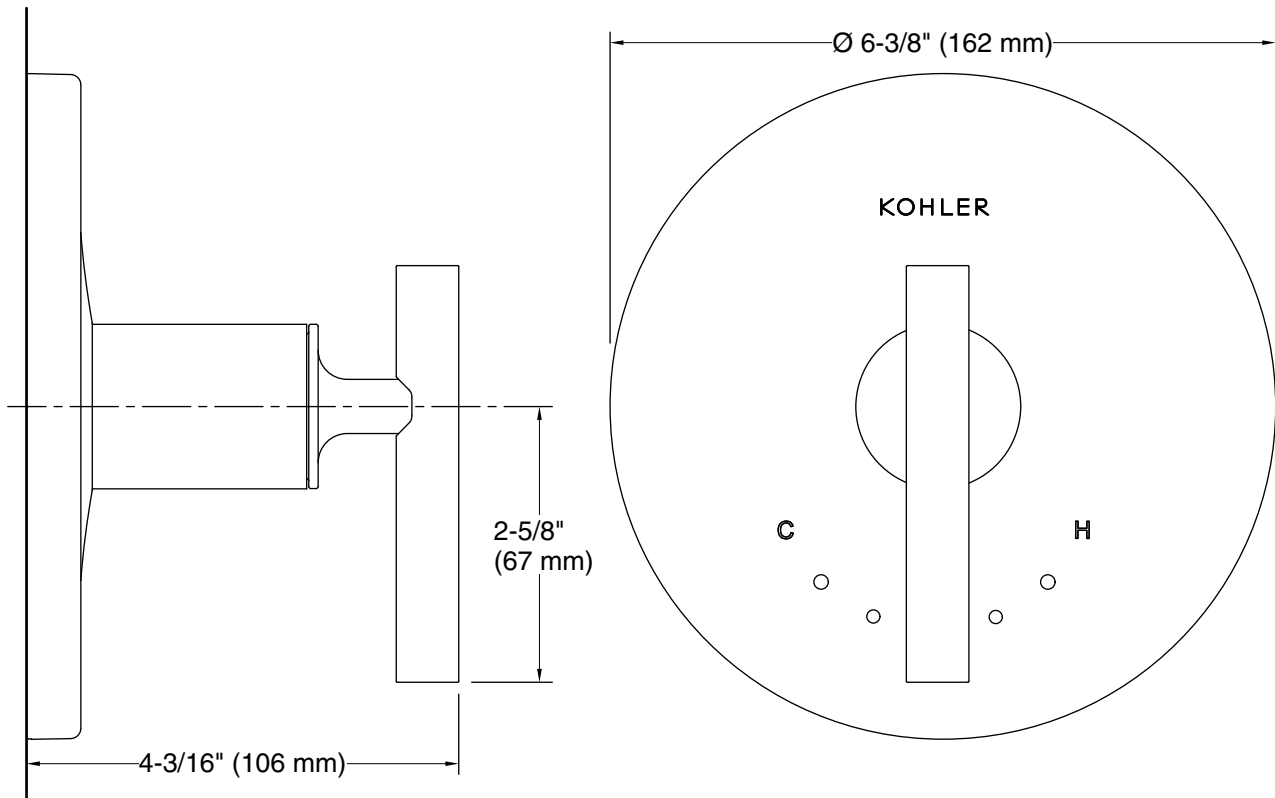

Technical Information

All product dimensions are nominal.

Notes

Install this product according to the installation instructions.

ADA, OBC, CSA B651 compliant when installed to the specific requirements of these regulations.