

Features

- 6 hydromassage jets can be individually adjusted for water flow and direction.
- Variable-speed pump for adjusting hydromassage intensity.
- 10 backjets target the lower back and shoulders to relieve tension and encourage deep breathing.
- Adjustable neckjet pillow with 2 jets provides a stimulating, stress-relieving neck massage.
- Chromatherapy lighting allows you to select a preferred color scheme to suit your mood.
- Built-in heater.
- Electronic keypad.
- Remote control.
- Safeguard® slip-resistant surface on bath floor.
- Drilled for grab bars (required); sold separately.

Material

- KOHLER® enameled cast iron.

Hydrotherapy

- 8 effervescence ports deliver gentle, caressing bubbles.
- Whirlpool.
- Backjets.
- Neckjets.
- Chromatherapy.

Installation

- Drop-in.
- Requires K-23856 cable pop-up bath drain and K-23857 bath drain trim (sold separately).

Required Products/Accessories

K-9653 Grab Bars

or

K-23856 1-1/2" cable pop-up bath drain

or

K-23857 Bath drain trim

Recommended Products/Accessories

K-1601 Bath/whirlpool footstop, removable

K-9498 3" Keypad Trim

K-9696 Whirlpool 6-Jet Trim Kit

K-587 Under-Mount Installation Kit

K-1179 Vinyl Tiling-in Bead

K-23726 Drain treatment

K-23725 Cast iron cleaner



Codes/Standards







ASME A112.19.1/CSA B45.2
ASME A112.19.7/CSA B45.10
ASTM F462
UL 1795
CSA C22.2 No. 218.2

KOHLER® Enameled Cast Iron Bath and Shower Base Lifetime Limited Warranty KOHLER® Hydrotherapy Components Five-Year Limited Warranty

See website for detailed warranty information.

Available Colors/Finishes

Color tiles intended for reference only.

Color	Code	Description
	0	White
	96	Biscuit
	NY	Dune
	95	Ice™ Grey
	58	Thunder™ Grey
	7	Black Black™

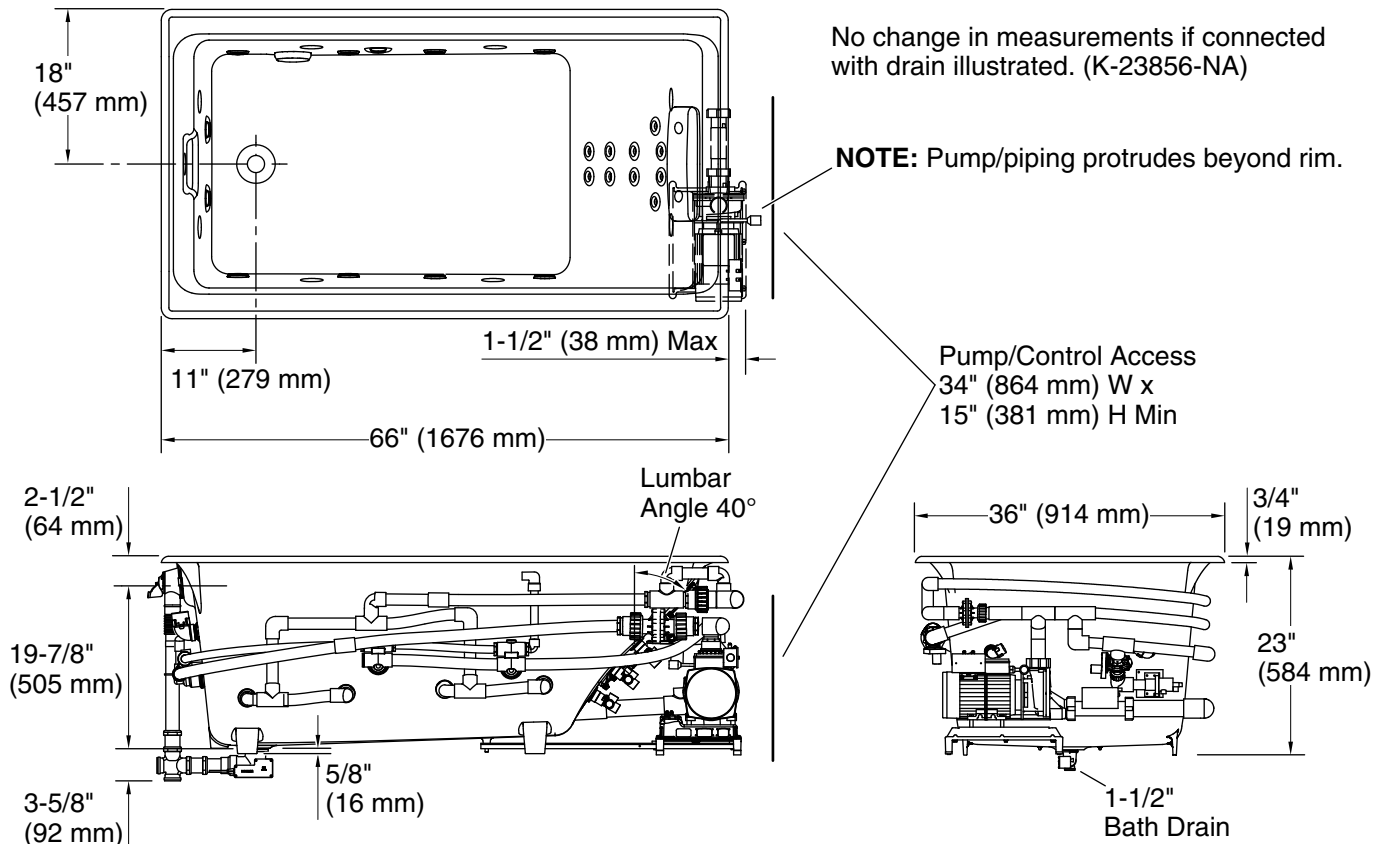

Required Electrical Service

One dedicated circuit required, protected with Class A Ground-Fault Circuit-Interrupter (GFCI). Outside North America, this device may be known as a Residual Current Device (RCD).

Pump, Heater: 240 V, 20 A, 50/60 Hz

Technical Information

All product dimensions are nominal.

Installation:	Drop-in
Drain location:	End
Basin area, bottom:	45" x 25" (1143 mm x 635 mm)
Basin area, top:	58" x 29" (1473 mm x 737 mm)
Weight:	510 lbs (231.3 kg)
Minimum floor load:	81 lbs/ft ² (395.5 kg/m ²)
Water depth:	18" (457 mm)
Water capacity:	96 gal (363.4 L)
Cutout:	Drop-in, 65-1/2" x 35-1/2" (1664 mm x 902 mm)
Electrical component rating:	Pump: 240 V, 11 A, 50/60 Hz Heater: 240 V, 6 A, 1500 W
Pump speed:	Variable

Notes

Measure your actual product for rough-in details.

Install this product according to the installation instructions.

The hot water supply should be 70% of the capacity of the bath or greater. Installations will vary.

Kit is required for under-mount installations (sold separately).

Cast iron whirlpools are extremely heavy, making some drop-in installations difficult.

Splitting the deck/surround is recommended if installing into a deck.