

### Features

- Arm features 5-3/8-inch reach.
- 1/2-inch NPT connection.

### Material

- Durable metal construction.
- KOHLER finishes resist corrosion and tarnishing.

### Installation

- Wall-mount



### Codes/Standards









ASME A112.18.1/CSA B125.1

### KOHLER® One-Year Limited Warranty

See website for detailed warranty information.

### Available Colors/Finishes

*Color tiles intended for reference only.*

Color	Code	Description
	CP	Polished Chrome
	SN	Vibrant® Polished Nickel
	AF	Vibrant® French Gold
	PB	Vibrant® Polished Brass
	G	Brushed Chrome
	BN	Vibrant® Brushed Nickel
	BV	Vibrant® Brushed Bronze
	2BZ	Oil-Rubbed Bronze

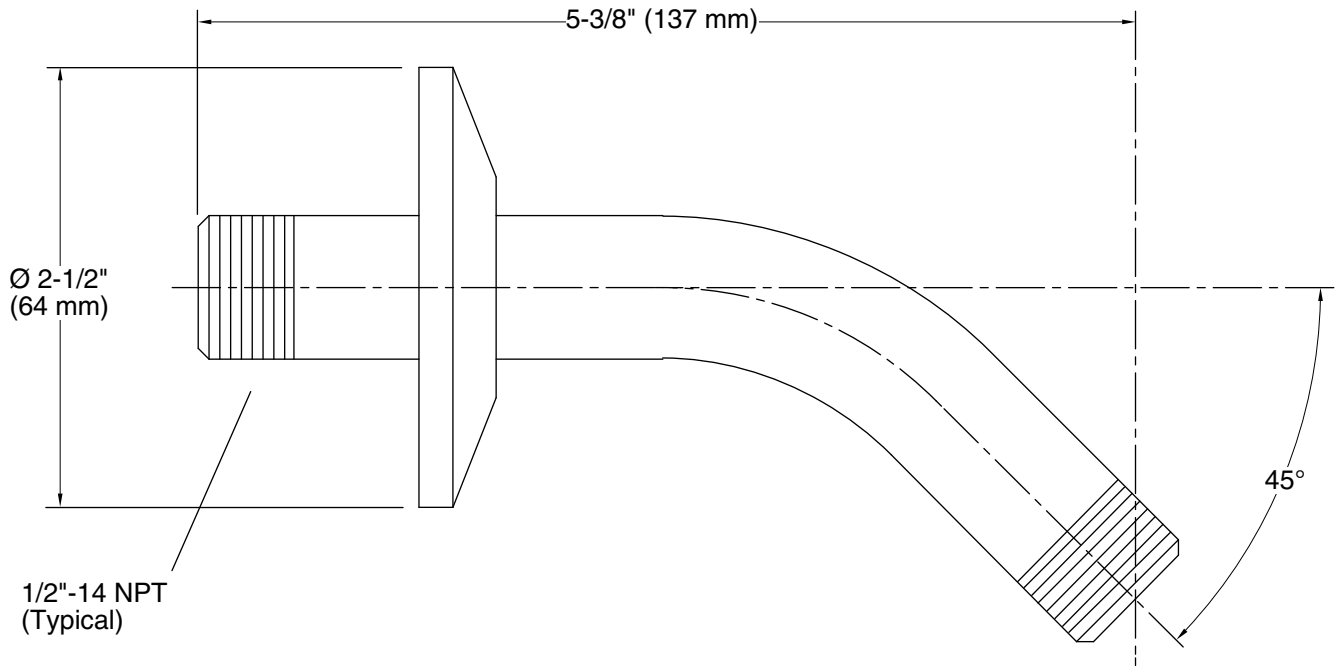

**Technical Information**

All product dimensions are nominal.