

### Features

- 17-gauge brass construction.
- Brass tailpiece.
- Adjustable trip lever pop-up drain.
- For above-the-floor installations.
- For use with Iron Works Historic™ freestanding baths.

### Recommended Products/Accessories

- K-23726 Drain treatment
- K-23723 Faucet cleaner



### Codes/Standards







ASME A112.18.2/CSA B125.2

### KOHLER® One-Year Limited Warranty

See website for detailed warranty information.

### Available Colors/Finishes

*Color tiles intended for reference only.*

Color	Code	Description
	CP	Polished Chrome
	SN	Vibrant® Polished Nickel
	AF	Vibrant® French Gold
	PB	Vibrant® Polished Brass
	BN	Vibrant® Brushed Nickel
	BV	Vibrant® Brushed Bronze
	2BZ	Oil-Rubbed Bronze

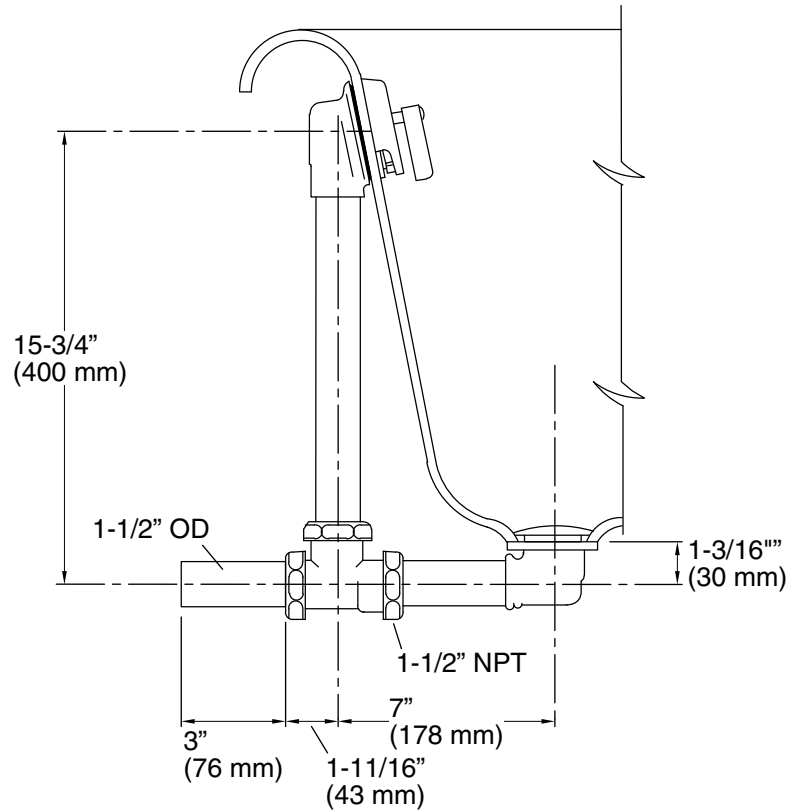

### Technical Information

All product dimensions are nominal.

### Notes

Install this product according to the installation guide.