

Features

- Two-function pull-down sprayhead allows you to switch from aerated stream to Sweep® spray.
- Sweep® spray creates a wide, forceful blade of water for superior cleaning.
- DockNetik®, a magnetic docking system that securely locks the sprayhead into place.
- Ceramic disc valves exceed industry longevity standards, ensuring durable performance for life.
- ProMotion® technology's light, quiet braided hose and swiveling ball joint make the pull-down sprayhead easier and more comfortable to use.
- MasterClean™ sprayface features an easy-to-clean surface that withstands mineral buildup.
- High-arch gooseneck spout and 360-degree spout rotation offer superior clearance for filling pots and cleaning.
- Temperature memory allows faucet to be turned on and off at the temperature set during prior usage.
- 1.5 gal/min (5.7 l/min) maximum flow rate [max at 60 psi (4.14 bar)]

Material

- Premium metal construction.
- KOHLER finishes resist corrosion and tarnishing.

Installation

- Two-hole installation.
- Flexible supply lines simplify installation.
- Remote valve configuration allows you to install the handle in an easy-to-access location.

Recommended Products/Accessories

K-77685 Single-Cartridge Water Filtration System
K-77686 Double-Cartridge Water Filtration System
K-77687 single replacement filter cartridge
K-77688 Replacement Filter Cartridges, Two-Pack



ADA CSA B651

Codes/Standards



ASME A112.18.1/CSA B125.1
NSF/ANSI 372
NSF/ANSI 61
DOE - Energy Policy Act 1992
California Energy Commission (CEC)
ADA
ICC/ANSI A117.1
CSA B651

KOHLER® Faucet Lifetime Limited Warranty

See website for detailed warranty information.

Available Colors/Finishes

Color tiles intended for reference only.

Color	Code	Description
	CP	Polished Chrome
	VS	Vibrant® Stainless
	BL	Matte Black

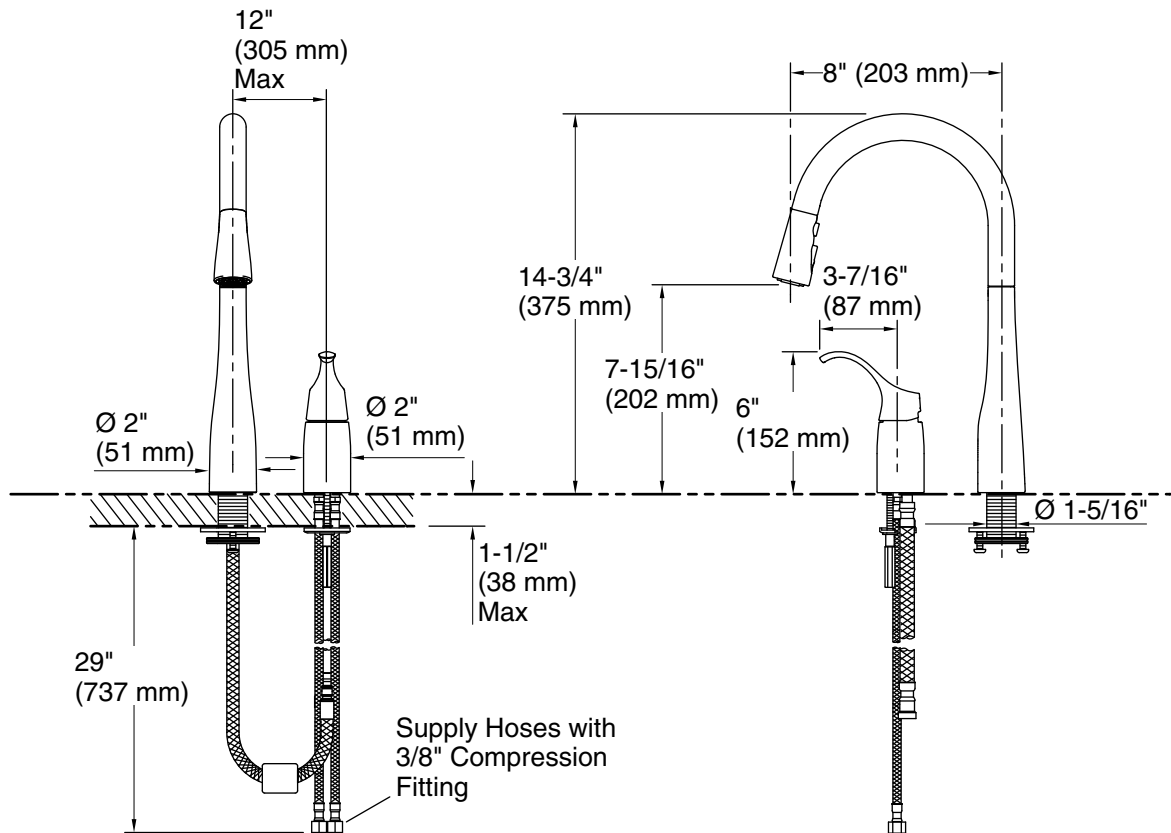

Technical Information

All product dimensions are nominal.

Faucet:

Flow rate: 1.5 gal/min (5.7 l/min)

Pressure: 60 psi (4.1 bar)

Notes

Install this product according to the installation guide.

ADA, CSA B651 compliant when installed to the specific requirements of these regulations.