

Features

- Vitreous china.
- One-piece.
- Regular height Round-front bowl.
- AquaPiston® flushing system.
- Includes left-hand polished chrome trip lever.
- 1.28 gpf (4.8 lpf).
- 2-1/8" (54 mm) fully glazed trapway.
- 12" (305 mm) rough-in.
- Includes Reveal® Q3 seat.
- Less supply.
- 9-1/4" (235 mm) x 6-3/4" (171 mm) water area.
- 25-5/8" (651 mm) x 16-3/4" (425 mm) x 24-1/4" (616 mm).
- Floor mount / Floor outlet.

Recommended Accessories

- K-75758 Cachet® Nightlight Quiet-Close™ Round-Front Toilet Seat
- K-76923 Puretide™ Quiet-Close™ Round-Front Manual Cleansing Toilet Seat
- K-5420 Low-Profile Bolt Caps
- K-9176 Trip Lever

Components

Additional included component/s: Tank Cover, Trip Lever, Bolt Accessory Pack, and Tank Accessory Pack.



Codes/Standards











ASME A112.19.2/CSA B45.1
DOE - Energy Policy Act 1992
EPA WaterSense®

KOHLER® One-Year Limited Warranty

See website for detailed warranty information.

Available Color/Finishes

Color tiles intended for reference only.

Color	Code	Description
	0	White
	96	Biscuit
	47	Almond
	NY	Dune
	95	Ice™ Grey
	G9	Sandbar
	33	Mexican Sand™
	K4	Cashmere
	58	Thunder™ Grey
	7	Black Black™

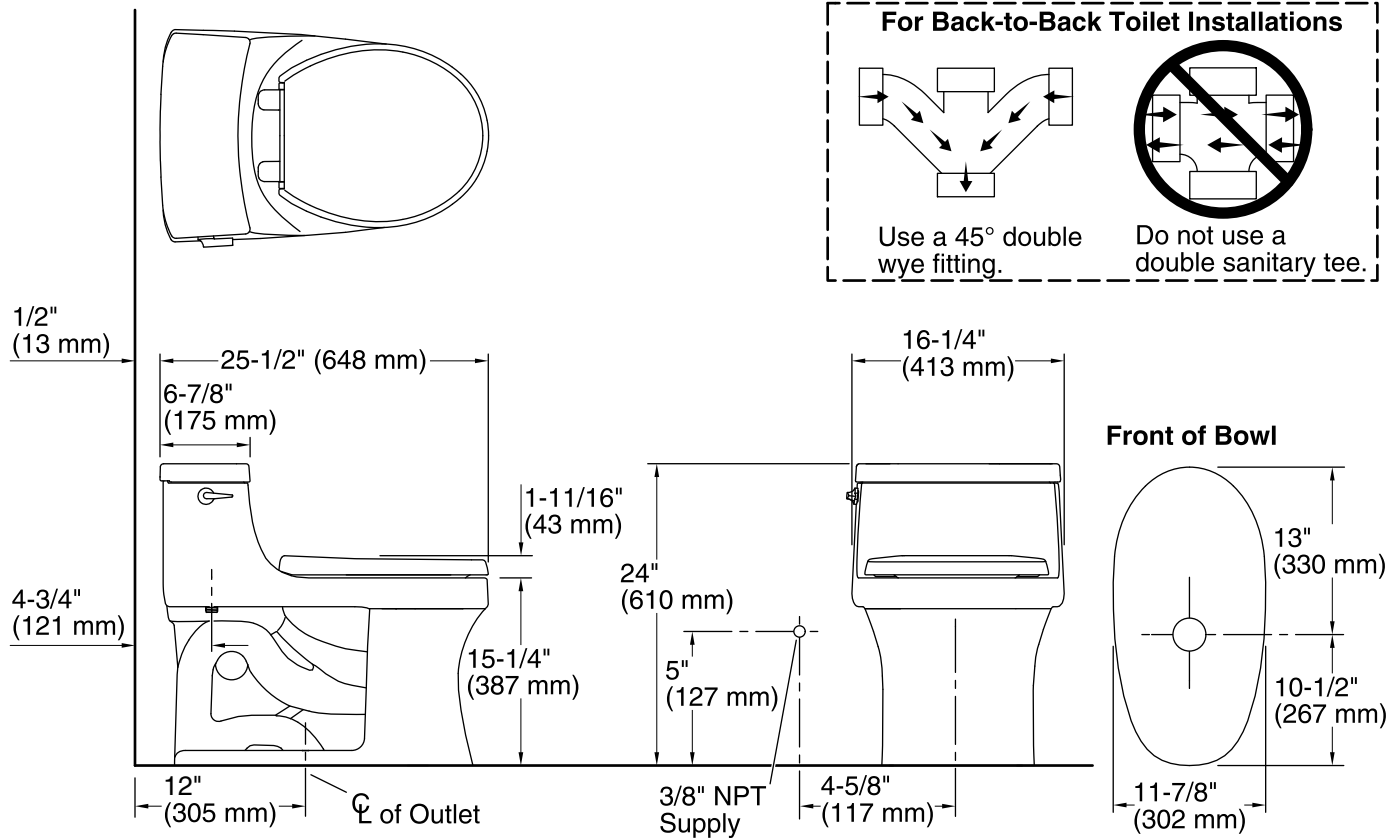

Technical Information

All product dimensions are nominal.

Toilet type:	One-piece, Floor-mount
Waste Outlet:	Floor
Bowl shape:	Round front
Flush type:	AquaPiston®
Trap passageway:	2-1/8" (54 mm)
Water Consumption	
Full:	1.28 gpf (4.8 lpf)
Water surface size:	9-1/4" x 6-3/4" (235 mm x 171 mm)
Rim to water surface:	6-5/16" (160 mm)
Rough-in:	12" (305 mm)
Seat-mounting holes:	5-1/2" (140 mm)

Fixture Supply Requirements

Min static pressure:	20 psi (137.9 kPa)
Max static pressure:	80 psi (551.6 kPa)

Notes

Install this product according to the installation instructions.

For back-to-back toilet installations: Use only a 45° double wye fitting.