

Features

- Oval basin.
- No faucet holes; requires wall- or counter-mount faucet.
- Coordinates with other products in the Serif collection.

Material

- KOHLER® enameled cast iron.

Installation

- Under-mount

Recommended Products/Accessories

K-9018 P-Trap

Included Components

Additional Components:

1193643 Basin clamps



ADA

CSA B651

Codes/Standards

ASME A112.19.1/CSA B45.2

ADA

ICC/ANSI A117.1













CSA B651

Lifetime Limited Warranty for KOHLER® Cast Iron Components

See website for detailed warranty information.

Available Colors/Finishes

Color tiles intended for reference only.

Color	Code	Description
	0	White
	FF	Sea Salt™
	96	Biscuit
	47	Almond
	FD	Cane Sugar™
	NY	Dune
	Y2	Sunlight
	95	Ice™ Grey
	G9	Sandbar
	KC	Vapour™ Blue
	KG	Vapour™ Green
	FT	Basalt
	20	Suede
	KA	Black 'n Tan

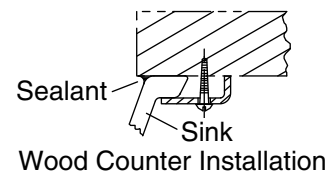
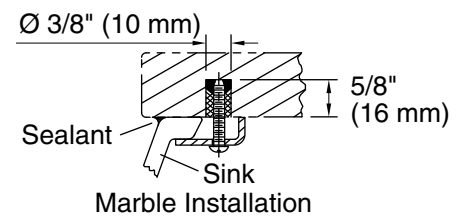
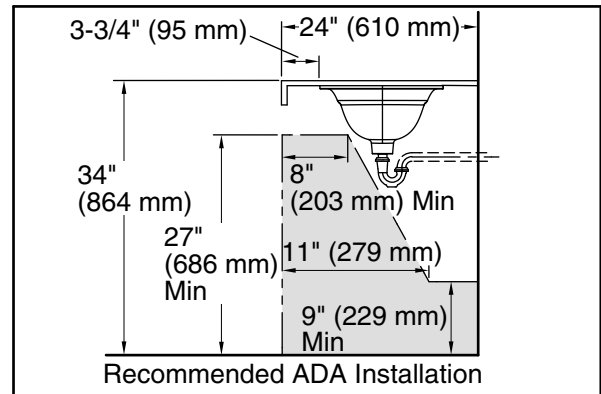
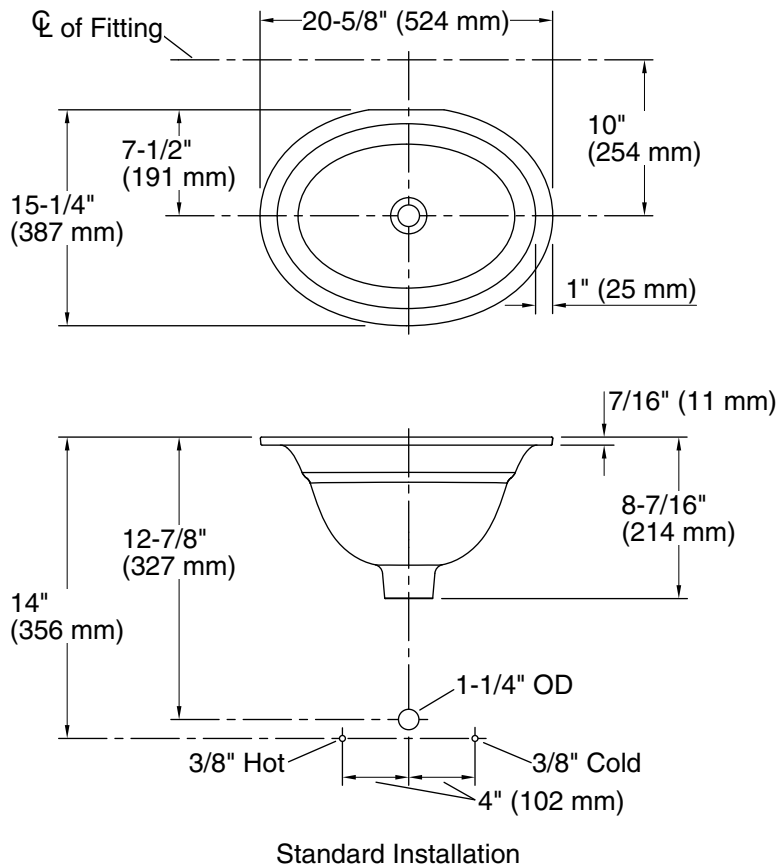

Technical Information

All product dimensions are nominal.

Bowl configuration:	Single
Installation:	Under-mount
Bowl area (Only):	Length: 17-3/4" (451 mm) Width: 12-3/4" (324 mm) Water depth: 6-7/16" (164 mm)
Drain hole:	1-5/8" (41 mm)
Template:	1039083-7, required, included

Notes

Install this product according to the installation instructions.

Supplied basin clamp assemblies require 1" (25 mm) minimum countertop thickness. Installer must supply anchors for thinner countertops.

NOTICE: The countertop manufacturer or cutter must use the cutout template provided with the product, or a current one provided by the Kohler Co. (call 1-800-4KOHLER). Kohler Co. is not responsible for cutout errors when the incorrect cutout template is used.

ADA, CSA B651 compliant when installed to the specific requirements of these regulations.