

Features

- Vitreous china.
- Drop-in.
- Round basin.
- With overflow.
- 8-inch centers.
- 18-7/8" (480 mm) diameter

Recommended Accessories

- K-7107 Decorative Drain
- K-7108 Decorative Drain
- K-7129 Drain
- K-9018 P-Trap



ADA

Codes/Standards











ASME A112.19.2/CSA B45.1
ADA
ICC/ANSI A117.1

KOHLER® One-Year Limited Warranty

See website for detailed warranty information.

Available Color/Finishes

Color tiles intended for reference only.

Color	Code	Description
	0	White
	96	Biscuit
	47	Almond
	NY	Dune
	95	Ice™ Grey
	G9	Sandbar
	33	Mexican Sand™
	K4	Cashmere
	58	Thunder™ Grey
	7	Black Black™

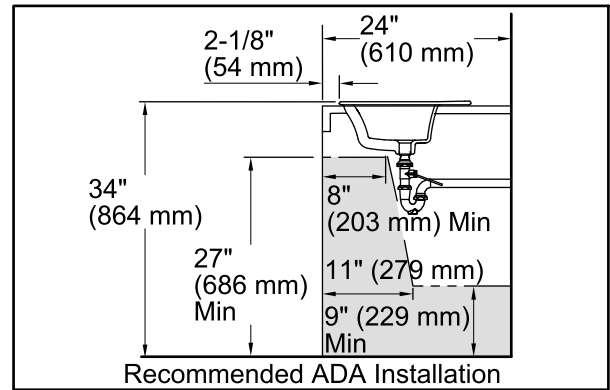
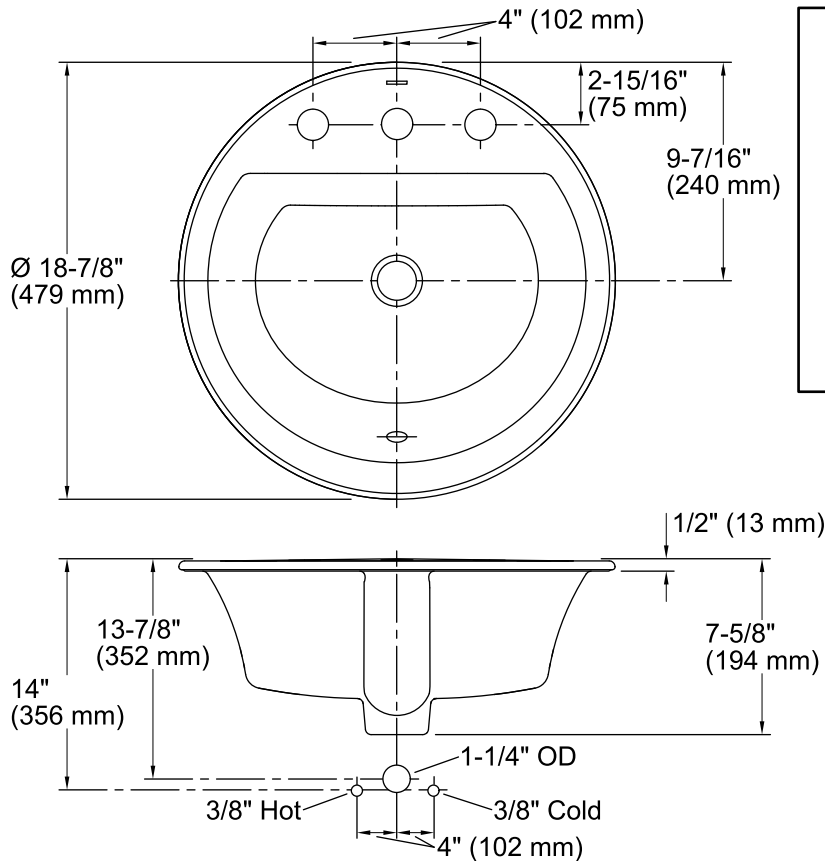

Technical Information

All product dimensions are nominal.

Bowl configuration:	Single
Installation:	Drop-In
Bowl area (Only)	Length: 12-1/2" (318 mm) Width: 16-5/16" (414 mm) Water depth: 4" (102 mm)
Number of deck holes:	3
Faucet hole(s):	1-3/8" (35 mm)
Drain hole:	1-3/4" (44 mm)
Template:	1155260-7, required, included

Notes

Install this product according to the installation instructions.

Spout must be 5" (12.7 cm) long (min) for adequate clearance into the lavatory when installed with the centerline as shown.

NOTICE: Countertop manufacturer or cutter must use the cut-out template provided with the product, or a current one provided by Kohler Co. (call 1-800-4-KOHLER). Kohler Co. is not responsible for cutout errors when the incorrect cut-out template is used.

ADA compliant when installed to the specific requirements of these regulations.