



Devonshire®

Undermount Bathroom Sink

K-2336

Features

- Oval basin.
- Overflow drain.
- No faucet holes; requires wall- or counter-mount faucet.
- Coordinates with other products in the Devonshire collection.

Material

- Vitreous china.

Installation

- Under-mount

Recommended Products/Accessories

K-9018 P-Trap

Included Components

Additional Components:

1193643 Basin clamps



ADA

CSA B651

Codes/Standards

ASME A112.19.2/CSA B45.1

ADA

ICC/ANSI A117.1









CSA B651

KOHLER® One-Year Limited Warranty

See website for detailed warranty information.

Available Colors/Finishes

Color tiles intended for reference only.

Color	Code	Description
	0	White
	96	Biscuit
	47	Almond
	NY	Dune
	95	Ice™ Grey
	G9	Sandbar
	K4	Cashmere
	58	Thunder™ Grey
	7	Black Black™

1-800-4KOHLER (1-800-456-4537)

Kohler Co. reserves the right to make revisions without notice to product specifications.

For the most current Specification Sheet, go to www.kohler.com.

12-7-2019 10:02 - US/CA

THE BOLD LOOK
OF **KOHLER**®

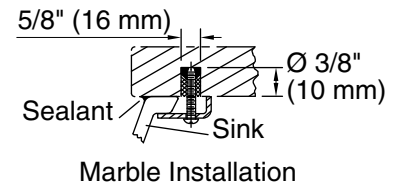
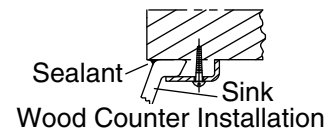
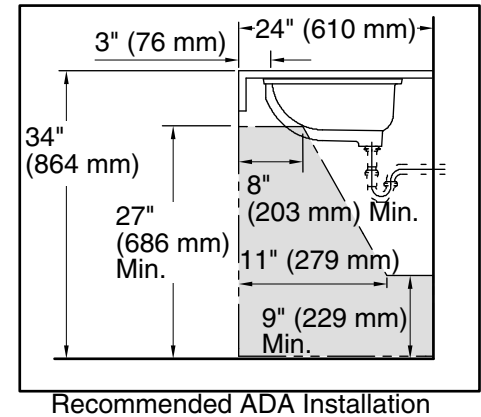
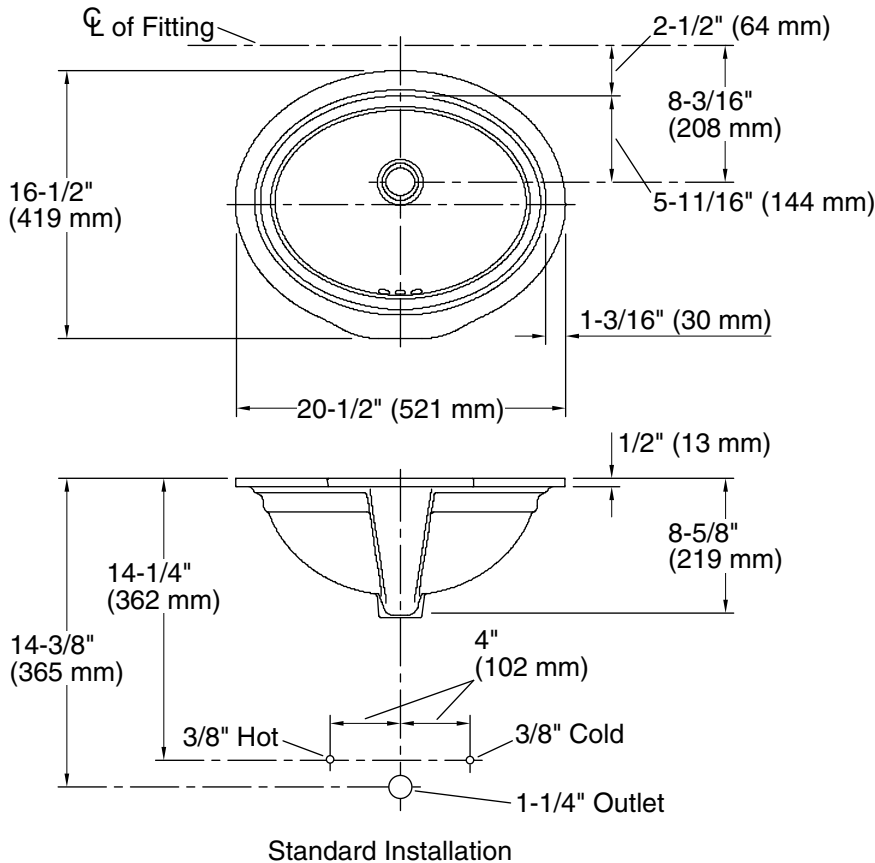

Technical Information

All product dimensions are nominal.

Bowl configuration:	Single
Installation:	Under-mount
Bowl area (Only):	Length: 18-1/8" (460 mm) Width: 14" (356 mm) Water depth: 4-3/16" (106 mm)
Drain hole:	1-3/4" (44 mm)
Template:	1050263-7, required, not included

Notes

Install this product according to the installation instructions.

NOTICE: Countertop manufacturer or cutter must use the current product template available at www.kohler.com, or by calling 1-800-4KOHLER. Kohler Co. is not responsible for cutout errors when the incorrect cutout template is used.

ADA, CSA B651 compliant when installed to the specific requirements of these regulations.